

A	B	C		D
1	SN1-001	1496	495	1/2
2	SN1-101	1594	332	1/2
3	SN1-102	1518	314	1/2
4	SN1-107	1594	332	1/2
5	SN1-901	1545	505	1/2
6	SN1-203	1017	352	2/2
7	SN1-301	984	331	2/2
8	SN1-302	484	304	2/2
9	SN1-303	484	314	2/2
10	SN1-401	984	60	2/2

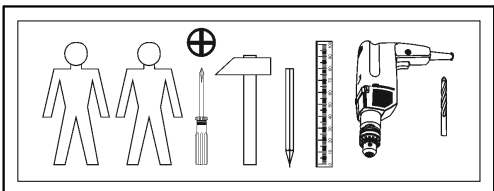

3x a43	3x b19	1x c310	20x $\phi 15 \times 12 \text{ mm}$ #16 r1	20x $\phi 8 \times 30 \text{ mm}$ f1	5x k1	50x l1	8x $\phi 5$ s4	
6x $\phi 3,5 \times 15 \text{ mm}$ p51	2x $\phi 4 \times 25 \text{ mm}$ p87	16x 20/9 r16	16x $\phi 16$ s2	1x n261	1x $\phi 3,5 \times 16 \text{ mm}$ p38	16x $\phi 5 \times 17 \text{ mm}$ d1	2x $\phi 8 \times 50 \text{ mm}$ f6	
7x $\phi 2,9 \times 16 \text{ mm}$ p55	7x 20x12x3,5/1 mm n108	2x r10						 1x

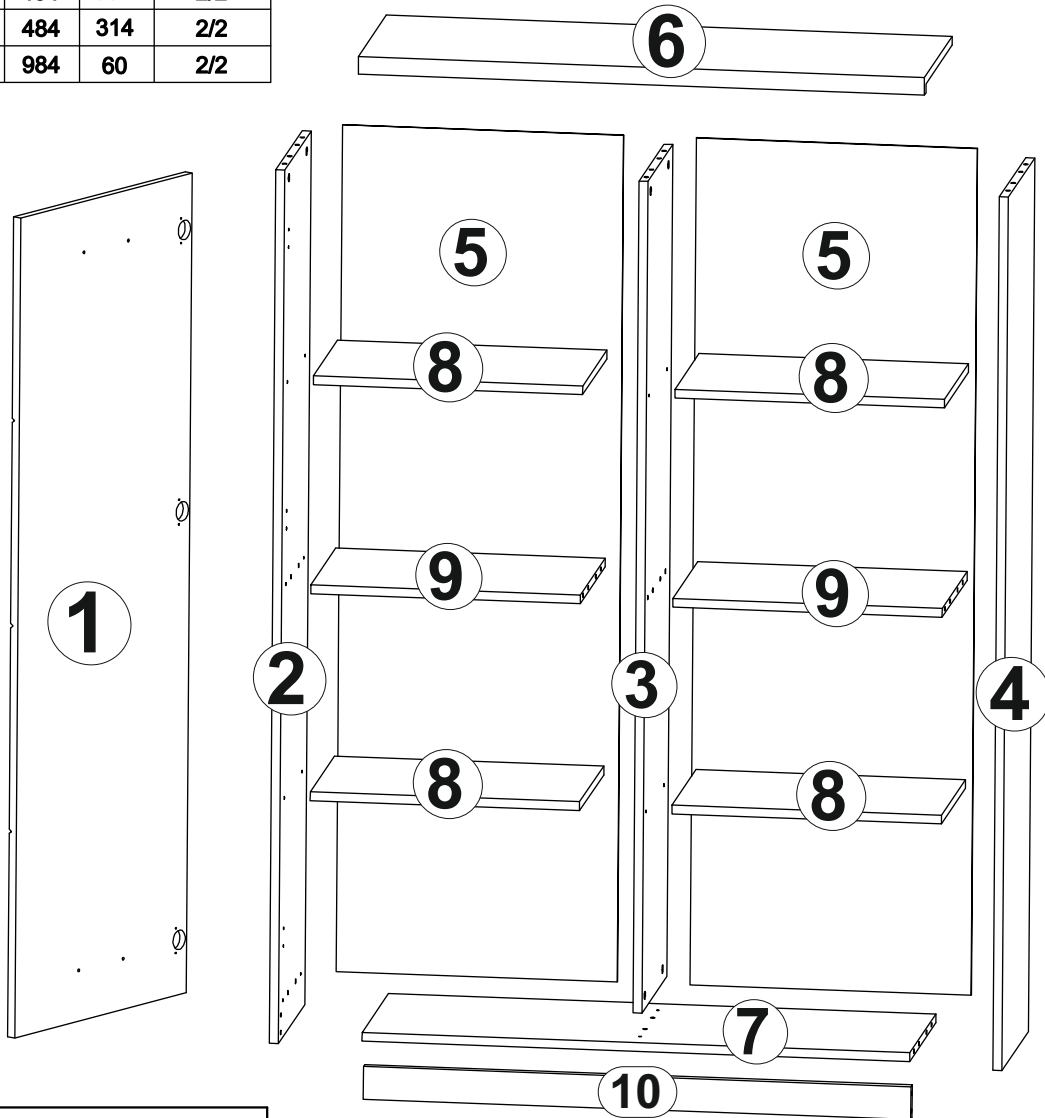
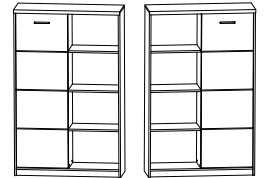
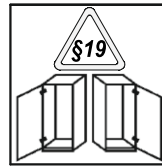
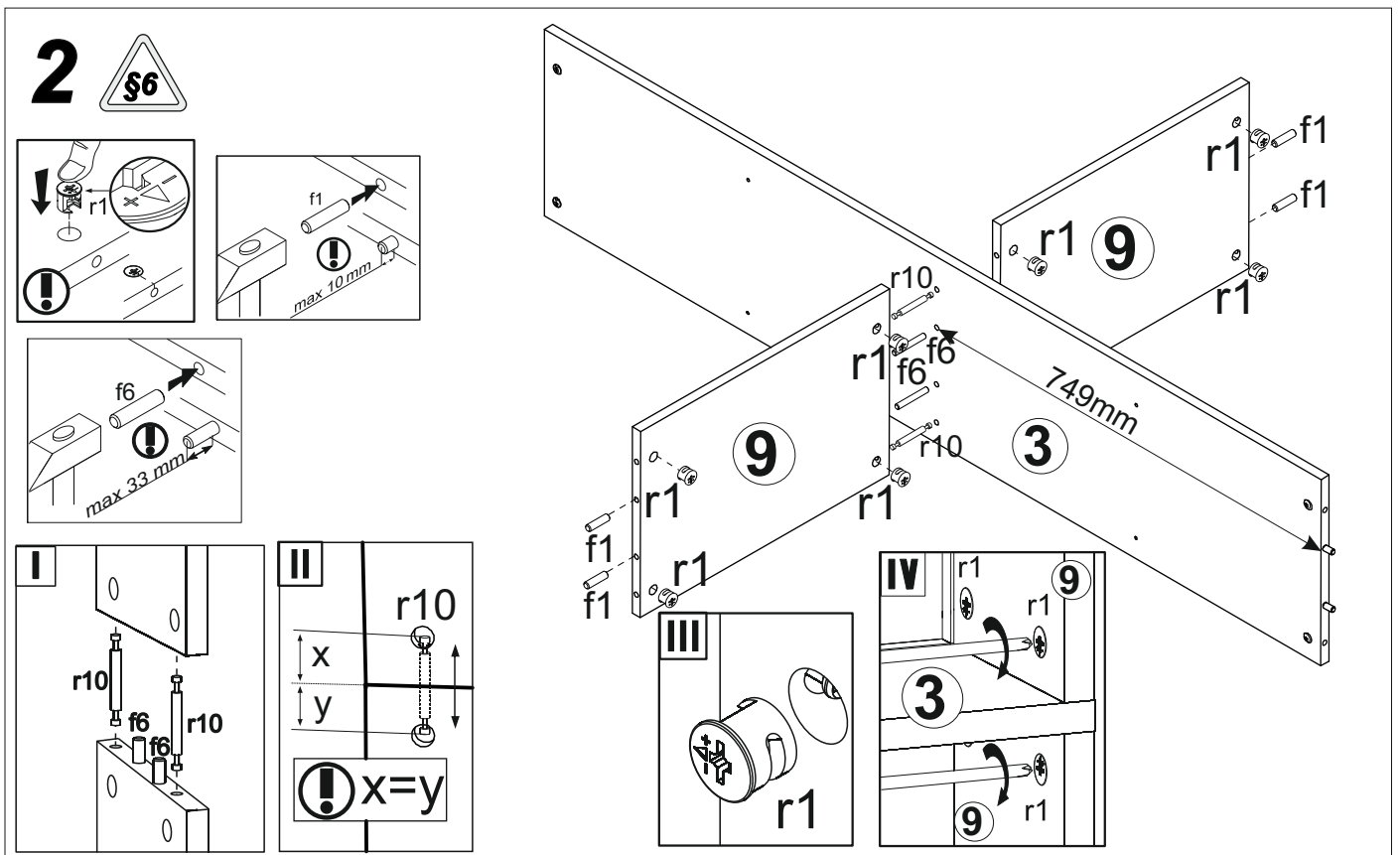
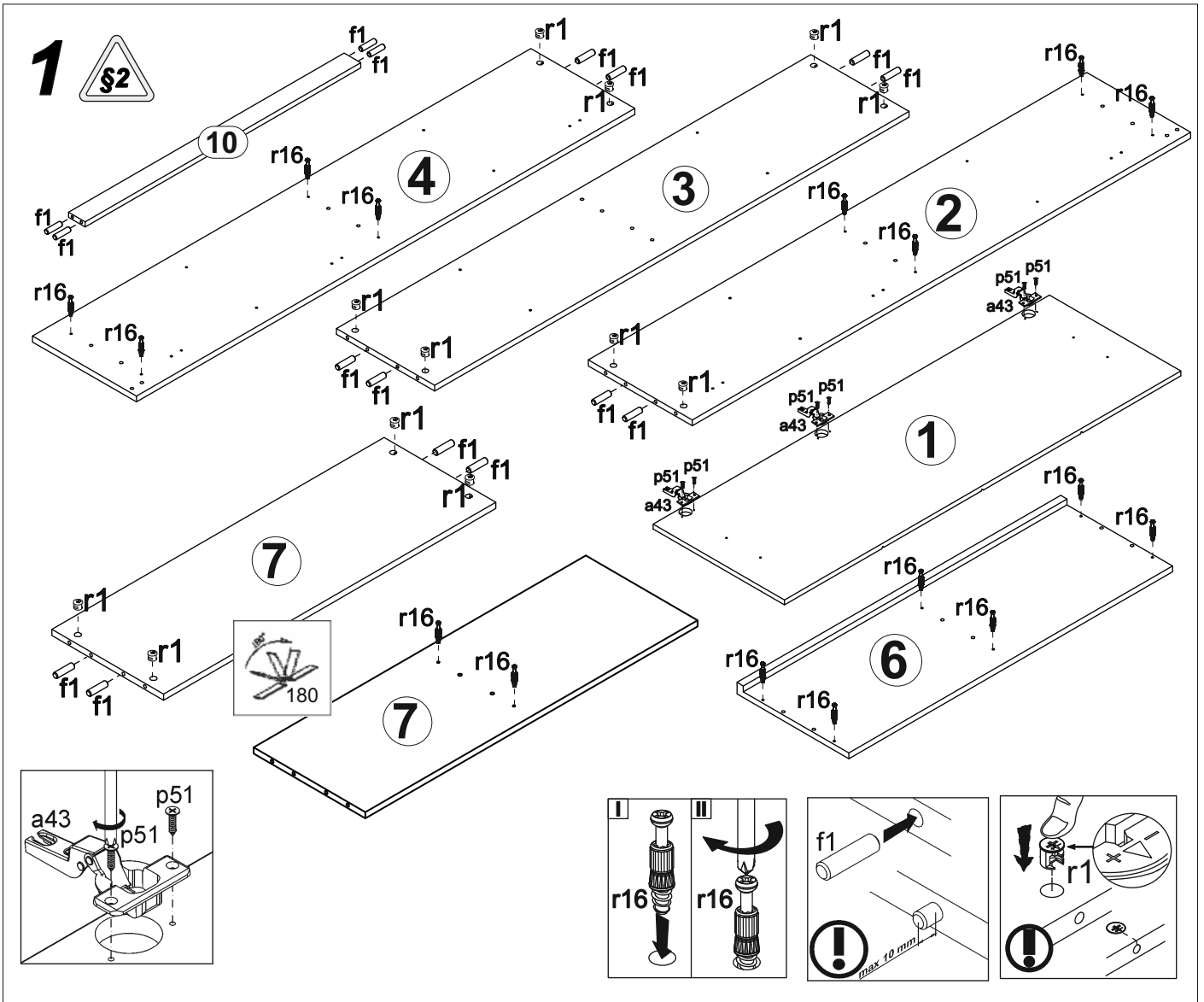

3

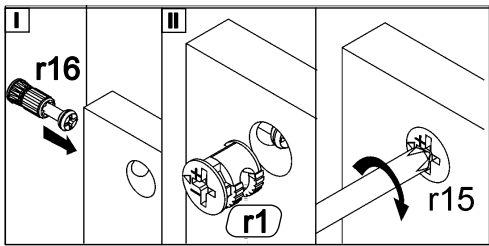
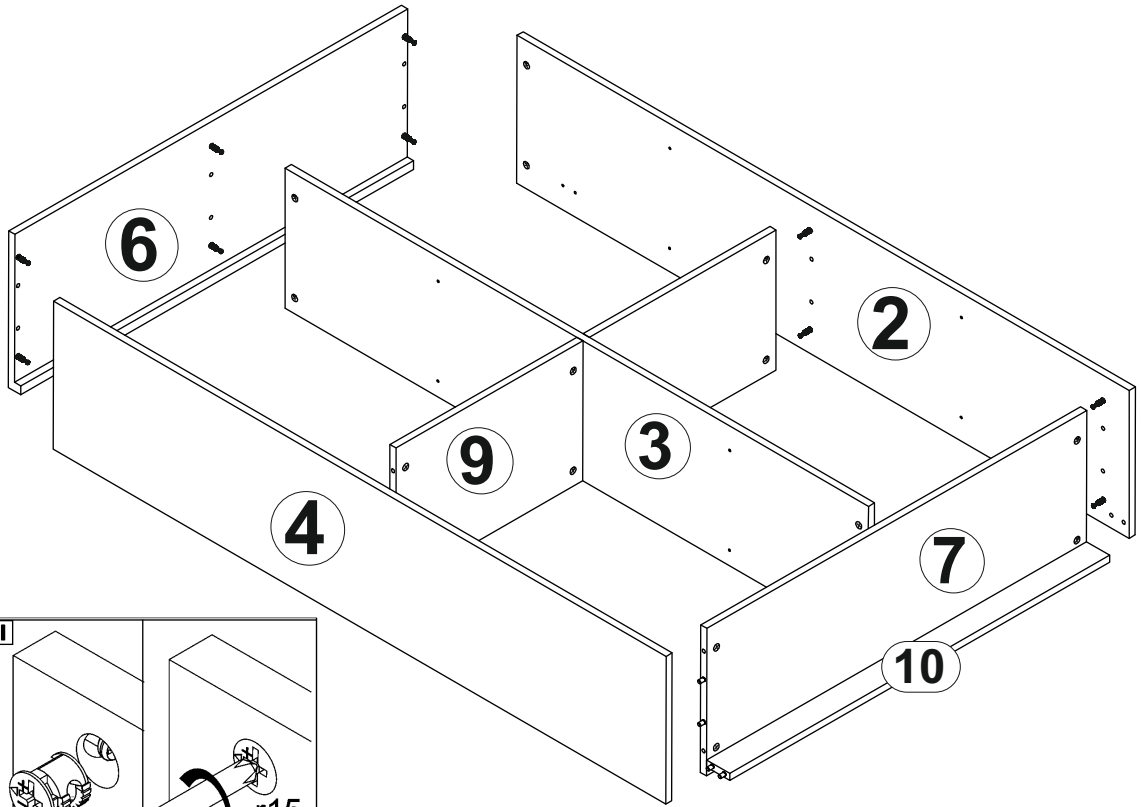

4

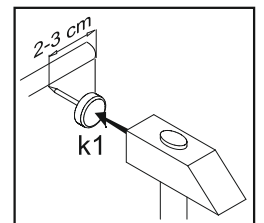
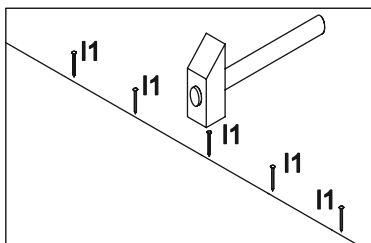
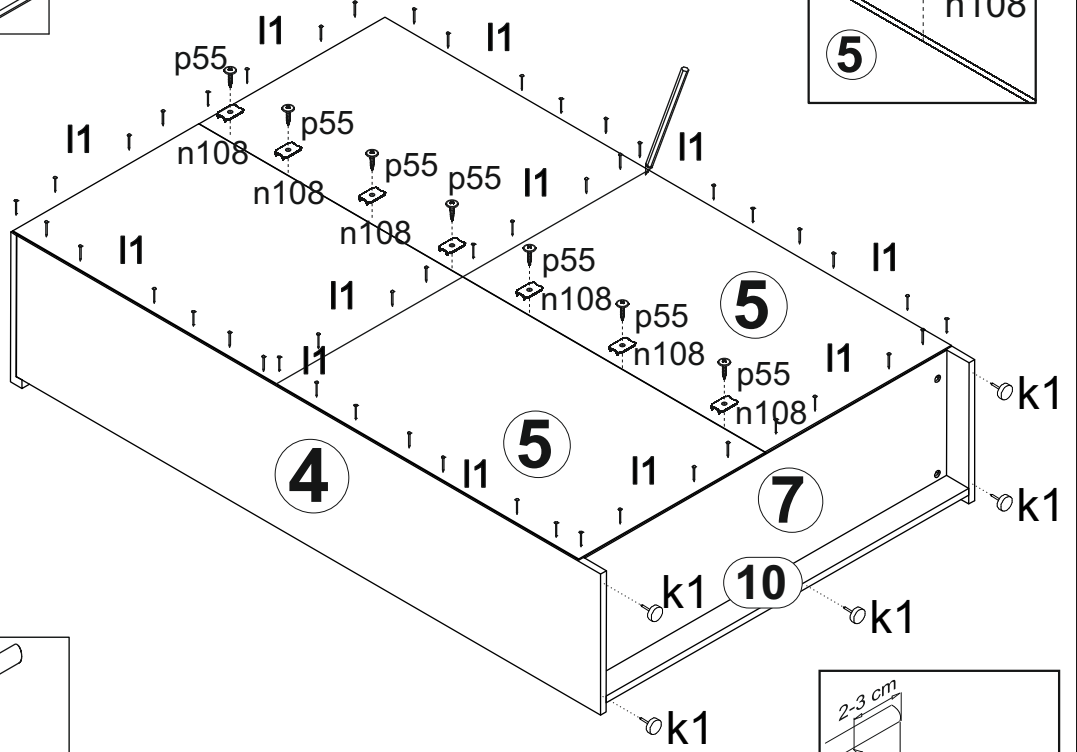
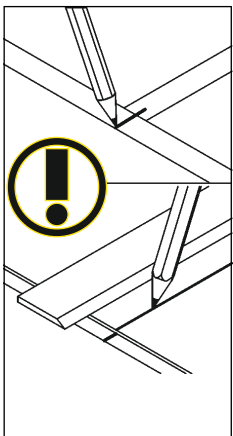
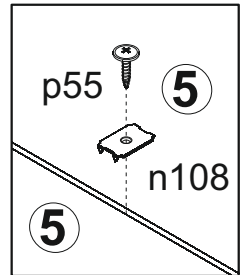
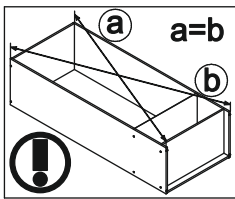

5

