

A	B	C		D
1	HM1- 029	856	1174	1/2
2	HM1- 028	1713	469	2/2
3	HM1-4402	1647	619	1/2
4	HM1-4403	1647	405	1/2
5	HM1-144	2016	250	2/2
6	HM1-145	1603	250	2/2
7	HM1-211	1731	60	2/2
8	HM1-030	856	1174	1/2

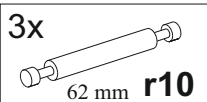
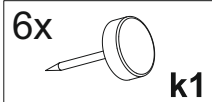
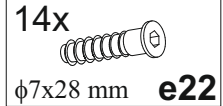
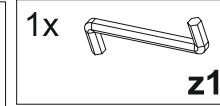
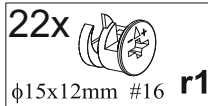
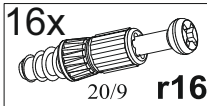
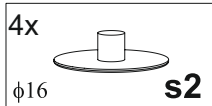
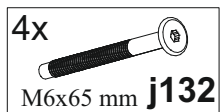
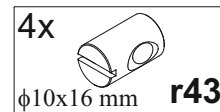
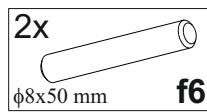
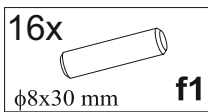
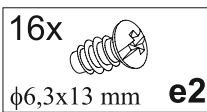
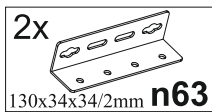
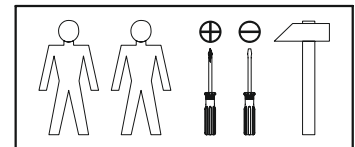
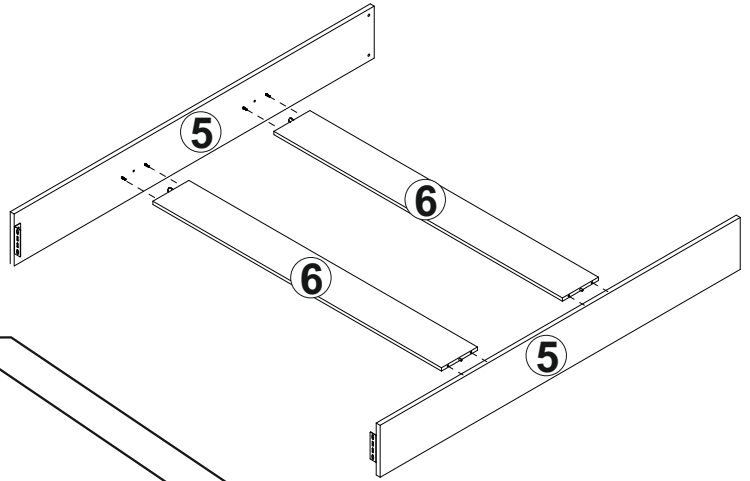
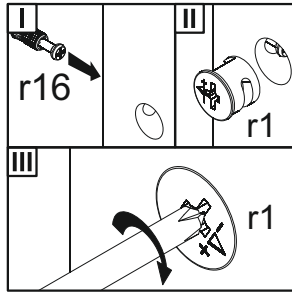

2**3**